

FIBER OPTIC CONNECTORS & COMPONENTS

SC - FC - ST[®]



ISO 9001 APPROVED



RADIALL[®]

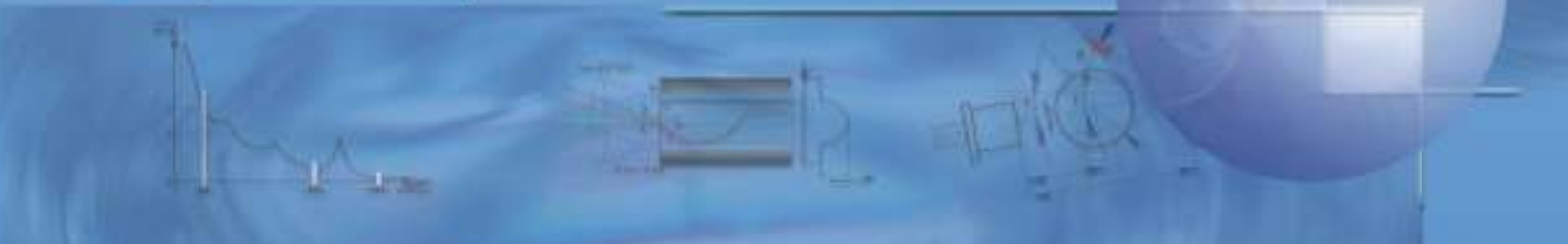

Radiall company profile

Fiber Optic Connectors

INDUSTRIAL RESOURCES - 11 facilities worldwide



Head office Rosny-sous-bois (France)

RADIALL CHATEAU-RENAULT - France

Multipin connectors - Moulding

RADIALL MICROCORD - France

Low loss cables

RADIALL ISLE D'ABEAU - France

Microwave components

Components and fiber optic connectors

RADIALL VOIRON - France

Screw machining

RADIALL VOREPPE - France

Plating - Coaxial connectors

RADIALL G.m.b.H. - Germany

Cable assemblies and fiber optic

RADIALL LTD - UK

Coaxial connectors

Components and fiber optic connectors

RADIALL PROTECTRON - India

Coaxial connectors - Microwave components

JERRIK INC - U.S.A. (Arizona)

Multipin connectors - Filtered connectors

RADIALL INC - U.S.A. (Connecticut)

Coaxial connectors

RADIALL SHANGHAI - China

Coaxial connectors

QUALITY ASSURANCE

RADIALL, as a TQM company, continually searches for improvements to the quality process. We operate a Quality Assurance Program that has been developed in accordance with the national and CECC agencies (equivalent to MILI45208 and MILC45662 standards). This program has enabled us to achieve QPL approval on several of our connector series. RADIALL's Quality Assurance Program operates at all levels of manufacturing from the initial raw incoming material to the final testing procedures just prior to shipping. All test equipment is part of the quality process and is continually inspected on a regular scheduled basis. All production plants in Europe are AQAP4NATO certified.



HIGH RELIABILITY

Reliability of interconnection systems is of the utmost importance in telecommunication applications. This industry need has led RADIALL to link high performance design, manufacturing and quality control. This has given the company the capability to produce connectors that will operate in the most stringent environments. The wide range of our product offering allows us to propose the best complete solution for your exact need.

Radiall company profile

Fiber Optic Connectors

RADIALL is a leading European connector manufacturer for wide range of fiber optic components. Since 1976 **RADIALL** has been designing and manufacturing both custom and standard connector interfaces for a variety of markets and applications.

Today, **RADIALL** is the privileged industrial partner of some major companies in the fields of telecommunications, energy and transport.

R & D

A team of skilled engineers to provide the most competitive solution thanks to the more than 20 years of Radiall experience in fiber optic.



Technologies

A large range of precision technologies including machining, etching, moulding and automated assembly packaging which enable high volume production of precision parts.



ISO 9001 certified

Approved qualification laboratory

3 production facilities in Europe

A worldwide commercial representation

See www.radiall.com for further information and press-releases

Radiall company profile	2 & 3
General	5 & 6
Standardization	7
Technology	8
SC series	
Performances	9
Simplex connectors	10 & 11
Duplex connectors	12 & 13
Simplex adaptors	14
Duplex adaptors.	15
FC series	
Performances	17
Connectors	18 & 19
Adaptors	20 & 21
Device housing receptacles	22
ST series	
Performances	23
ST I & ST II connectors	24 & 25
ST secure & BeST connectors.	26
ST Sealed connectors	27
Adaptors	28
Device housing receptacles	29
Accessories.	31
Termination tooling.	32
Tuning tool	33
Inter-series adaptors	34 & 35
Numerical index	36 & 37
New product information	38

SC F728 & FC F729

Radiall, thanks to its new range of **SC** and **FC connectors** has greatly improved these traditional fiber optic connectors in terms of technology and reliability.

One-piece connector tunability⁽¹⁾

6 tuning positions available. For this technique a high-accuracy tuning tool has been developed. It allows optimizing a cable assembly in a matter of seconds. The tuning process follows the cabling operation and is performed at the front of the connector. Thanks to this new concept, optimization at any time, of any standard cable assembly using Radiall connectors now becomes possible.

Secured bonding⁽¹⁾

An exclusive patented system protects the floating mechanism, during the resin-injection process. A slot on the crimping body allows the removal of the syringe without the needle touching any sensitive area.

Crimping reliability⁽¹⁾

A mini metallic tube is inserted between the fiber and the cable jacket to protect the fiber and avoid any stress. The shape of the crimping ring is adapted to ensure excellent cable retention.

Protection boot⁽¹⁾

The unique shape of this boot "hugs" the cable so that optical performances are maintained even when the cable is twisted or pulled at an angle. The Vo rated material has been selected to ensure that smoke and gas emission during a possible fire are minimized. Meets Bellcore requirements.

Duplex SC connector

The fully-removable duplex brace is a very innovative solution. The brace is fitted after the cabling operation. When the installation procedures require, the identification of the optical channel (A or B) can be changed by reversing the cover.

Standardisation of components

Boots and crimping rings are the same for both SC and FC connectors. It makes it very easy for the operator to freely manage their supplies according to the cable to be connected.

Cabling procedures standardisation

Identical stripping dimensions and the same crimping hexagons simplify the tooling requirements and operator training.

SC and FC connectors are available in PC and APC versions.

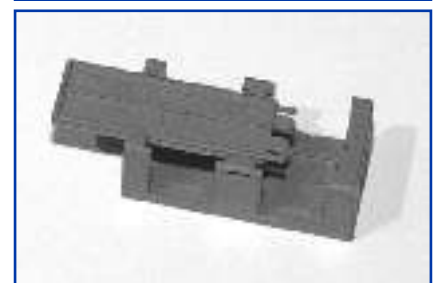

(1) RADIALL Patented Technology

ST F709

A number of innovative benefits from the latest generation of **SC** and **FC connectors** have been integrated into the **ST series**

Crimping reliability

The ST connector is available with the "secure crimp" option to meet the requirements of operators using the connectors in sensitive environments.

Protection boot

The entire ST range includes the new rear boot in every cable version.



For all SC, FC, ST Series

Extended Coding System

All product is available as a connector body dedicated to a type of cable, or a basic version allowing the operator to order accessories separately (protection boots, crimping rings, etc.)

Packed per unit or per 100.



Connectors are arranged in a rigid blister pack* containing no more than 100 connectors.

Connectors are held vertically in individual cells, with the optic tip upwards.

A transparent cover provides dust protection and allows viewing the contents.

**Recyclable materials*

ST is a registered trade mark of AT&T

Type	Interface	Sectional Specifications	Product Specifications
SC-PC SIMPLEX	IEC 61754-4 (1997 issue)	Singlemode <ul style="list-style-type: none"> • Untuned PC connector IEC 60874-14-5 (1997 issue) • Tuned PC connector IEC 60874-14-2 (1997 issue) • PC and APC adaptors IEC 60874-14-2 (1997 issued) Multimode <ul style="list-style-type: none"> • Connector IEC 60874-14-1 (1997 issue) • Adaptor IEC 90874-14-4 (1997 issue) 	Singlemode <ul style="list-style-type: none"> • Connector and Adaptor EN 186 510
SC-PC DUPLEX		Multimode <ul style="list-style-type: none"> • Connector IEC 60874-14-10 	Multimode <ul style="list-style-type: none"> • Connector and Adaptor EN 186515
SC-APC SIMPLEX	Amendment to IEC 61754	Singlemode <ul style="list-style-type: none"> • 8° untuned connector IEC 60874-14-10 • 8° tuned connector IEC 60874-14-9 	Singlemode <ul style="list-style-type: none"> • Connector and adaptor EN 186550
FC-PC	IEC 61754-13 (no published : 86B1163/FDIS)		Singlemode <ul style="list-style-type: none"> • Connector and Adaptor EN 186 500
FC-APC SIMPLEX	No IEC standardization	Singlemode <ul style="list-style-type: none"> • 8° untuned connector CECC 86115 804 • 8° tuned connector CECC 86115 805 • "N" keyed 2.09-2.14 (connector) 2.15-2.20 (adaptor) 	
ST Simplex	IEC 61754-2 (1996 issue)	Singlemode connector IEC 60874-10-2 (1997 issue) Multimode connector IEC 60874-10-1 (1997 issue) Singlemode/Multimode Adaptor IEC 60874-10-3 (1997 issue)	

PC physical contact
SC/FC/ST /beST

Pull-proof
Performances are maintained even in the event of cable traction
SC/FC/beST

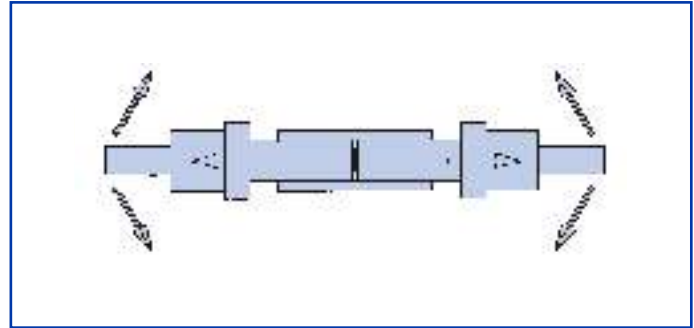
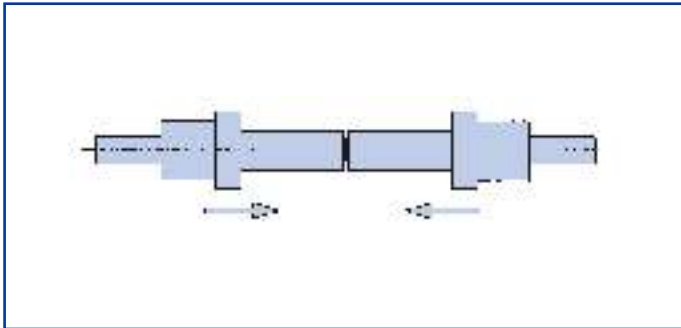

Optical ceramic ferrule geometry

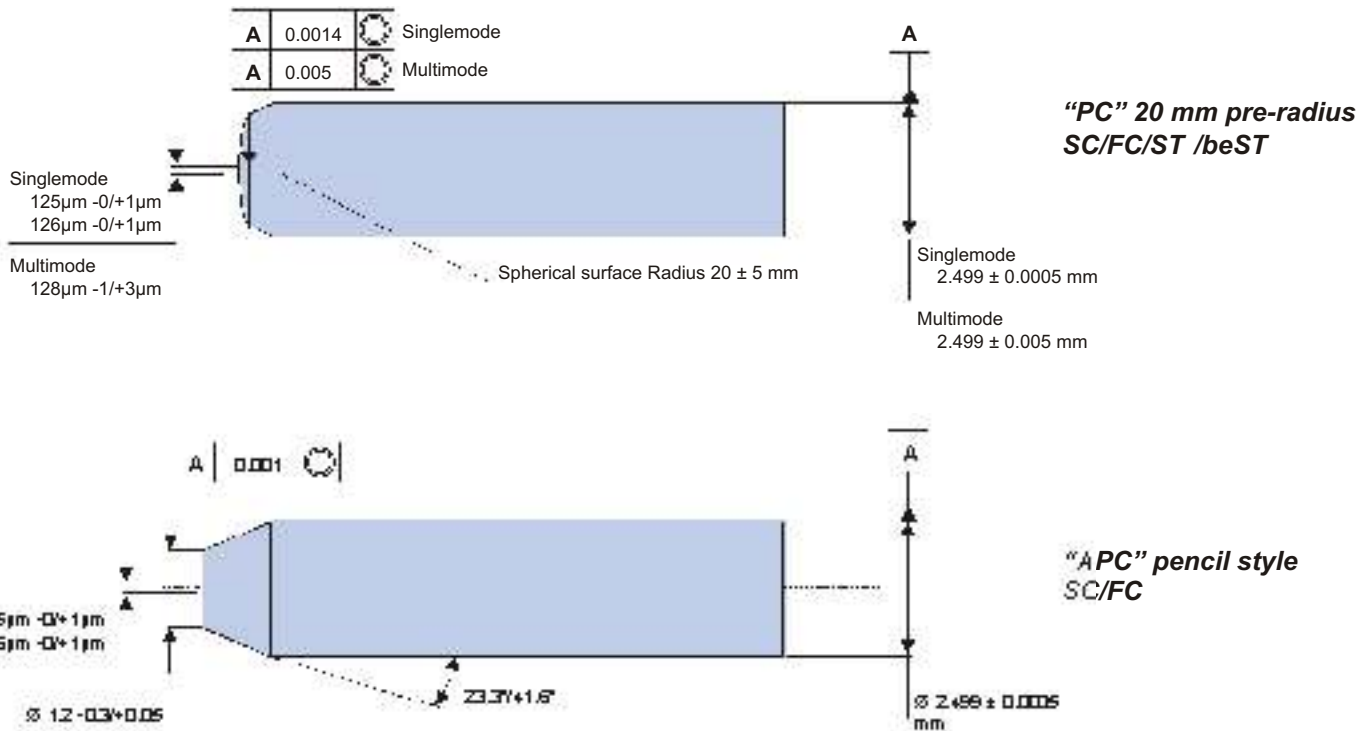

Note : depending on fiber or cable construction

INSERTION LOSS

	Singlemode PC	Singlemode PC "tuned"	Singlemode APC	Singlemode APC "tuned"	Multimode PC
Attenuation plug mated with reference plug IEC 61300-3-4/1310 and 1550nm/LD					
Mean	<0.20 dB	<0.20dB	<0.20 dB	<0.20 dB	<0.20dB
Standard deviation	0.14 dB	0.14 dB	0.15 dB	0.15 dB	0.08 dB
Peak	<0.8dB,97%	<0.6dB,99%	<0.8dB,97%	<0.6dB,99%	

(1) Attenuation of random mated connectors IEC 61300-3-34

RETURN LOSS

IEC 61300-3-6

Polishing option	Singlemode PC	Singlemode APC	Multimode PC 50/125 & 62.5/125
PC	>30 dB	>60 dB	>20 dB
SPC	>40 dB	-	-

UPC : automatic polishing machine

- **Repeatability** 0.10 dB (Maximum loss variation, IEC 61300-2-2)
- **Operating temperature** -40°C/+70°C
- **Storage temperature** -40°C/+85°
- **Cable traction** 0.9mm and tube : 10N
2 to 3mm cable : 100N
- **Mechanical endurance** 500 matings

APPLICATIONS

- Telecommunication networks (SONET/ATM)
- Broadband subscriber networks
- Fiber Management Systems
- Active device termination

Features



- Push-pull latching system
- One-piece Tunable connector (adjustable to 6 positions)
- Pull-proof
- "PC" pre-radius (20mm) zirconia ceramic ferrule
- "APC" pencil zirconia ceramic ferrule
- Secure crimping (double ferrule)
- Secure bonding
- Cable range : 0.9 to 3mm, tight or semi-loose structure
- Boots and plug housings color : Multimode PC : Beige
Singlemode PC : Blue

Cable Diameter (mm)	Packaging	PC125 Singlemode (blue)	PC126 Singlemode (blue)	PC128 Multimode (beige)	PC230 Multimode (beige)	APC125 Singlemode (green)	APC126 Singlemode (green)
Level "zero" (1)	100	F 728 101 000	F 728 102 000	F 728 103 000	-	F 728 111 000	F 728 112 000
0.9 (Buffer)	1	F 728 001 100	F 728 002 100	F 728 003 100	-	F 728 011 100	F 728 012 100
0.9 (Buffer)	100	F 728 101 100	F 728 102 100	F 728 103 100	-	F 728 111 100	F 728 112 100
0.6/1 (tube)	1	F 728 001 200	F 728 002 200	-	-	-	-
0.6/1 (tube)	100	F 728 101 200	F 728 102 200	-	-	-	-
0.8/1.6 (tube)	1	F 728 001 300	F 728 002 300	-	-	-	-
0.8/1.6 (tube)	100	F 728 101 300	F 728 102 300	-	-	-	-
1.6	1	F 728 001 400	F 728 002 400	F 728 003 400	-	F 728 011 400	F 728 012 400
1.6	100	F 728 101 400	F 728 102 400	F 728 103 400	-	F 728 111 400	F 728 112 400
2	1	F 728 001 500	F 728 002 500	F 728 003 500	-	F 728 011 500	F 728 012 500
2	100	F 728 101 500	F 728 102 500	F 728 103 500	-	F 728 111 500	F 728 112 500
2.4	1	F 728 001 600	F 728 002 600	F 728 003 600	-	F 728 011 600	F 728 012 600
2.4	100	F 728 101 600	F 728 102 600	F 728 103 600	-	F 728 111 600	F 728 112 600
3	1	F 728 001 700	F 728 002 700	F 728 003 700	F 728 005 700	F 728 011 700	F 728 012 700
3	100	F 728 101 700	F 728 102 700	F 728 103 700	F 728 105 700	F 728 111 700	F 728 112 700

Thanks to our **SC removable duplex brace**, a simplex installation can be changed at any time to a duplex one. The duplex brace can be ordered separately : see SC DUPLEX CONNECTORS.

(1) the level "zero" is supplied without boots or crimp sleeves and allows the user to manage his cable diameters, colour of the boots, etc...according to the situation.

All accessories (boots, crimp sleeves, etc...) can be ordered separately. These accessories are common to SC and FC connectors. See page 31 for part numbers.

Simplex connectors

SC series

Fiber Optic Connectors

Plug housing
(Beige, Blue, Green)

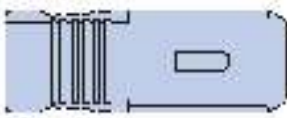

[inches]

“PC” optical sub-assembly

PC125 singlemode
PC126 singlemode
PC128 multimode

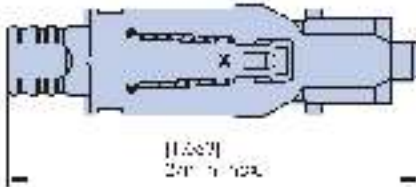

“APC” optical sub-assembly

APC125 singlemode
APC126 singlemode

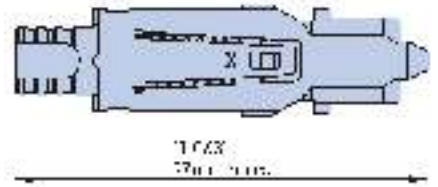

Cable diameter mm	Boots / Accessories	Mechanical dimensions Mm/Inch
0.9 mm		
0.6/1 mm		
0.8/1.6 mm		
1,6 - 2 - 2.4 - 3 mm		

Inside diameter of crimp rings varies according to cable diameter (2, 2.4 or 3 mm).

Rear part of the boot varies according to cable diameter (0.6/1) - (0.8/1.6 ; 2 - 2.4) - (3 mm)

Features



- Removable duplex brace
- Push-pull latching system
- One-piece Tunable connector (adjustable to 6 positions)
- Pull-proof
- "PC" pre-radius (20mm) zirconia ceramic ferrule
- "APC" pencil zirconia ceramic ferrule
- Secure crimping (double ferrule)
- Secure bonding
- Cable range : 0.9 to 3mm, tight or semi-loose structure
- Boots and plug housings color : Multimode PC : Beige
Singlemode PC : Blue

Cable Diameter (mm)	Packaging	PC125 Singlemode (blue)	PC126 Singlemode (blue)	PC128 Multimode (beige)	PC230 Multimode (beige)	APC125 Singlemode (green)	APC126 Singlemode (green)
0.9	1	F 728 401 100	F 728 402 100	F 728 403 100	-	F 728 411 100	F 728 412 100
0.9	100	F 728 501 100	F 728 502 100	F 728 503 100	-	F 728 511 100	F 728 512 100
0.6/1 (tube)	1	F 728 401 200	F 728 402 200	-	-	-	-
0.6/1 (tube)	100	F 728 501 200	F 728 502 200	-	-	-	-
0.8/1.6 (tube)	1	F 728 401 300	F 728 402 300	-	-	-	-
0.8/1.6 (tube)	100	F 728 501 300	F 728 502 300	-	-	-	-
2	1	F 728 401 500	F 728 402 500	F 728 403 500	-	F 728 411 500	F 728 412 500
2	100	F 728 501 500	F 728 502 500	F 728 503 500	-	F 728 511 500	F 728 512 500
2.4	1	F 728 401 600	F 728 402 600	F 728 403 600	-	F 728 411 600	F 728 412 600
2.4	100	F 728 501 600	F 728 502 600	F 728 503 600	-	F 728 511 600	F 728 512 600
3	1	F 728 401 700	F 728 402 700	F 728 403 700	-	F 728 411 700	F 728 412 700
3	100	F 728 501 700	F 728 502 700	F 728 503 700	-	F 728 511 700	F 728 512 700

All accessories (boots, crimp sleeves, etc...) can be ordered separately. These accessories are common to SC and FC connectors. See page 31 for part numbers.

The Duplex brace is available separately using following part numbers :

	Beige (multimode)	Blue (singlemode PC)	Green (singlemode APC)
	F 718 100 000	F 718 101 000	F 718 102 000

Pack of 100 duplex braces.

Duplex connectors

SC series

Fiber Optic Connectors

Plug housing
(Beige, Blue, Green)

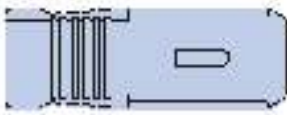

[inches]

“PC” optical sub-assembly

PC125 singlemode
PC126 singlemode
PC128 multimode

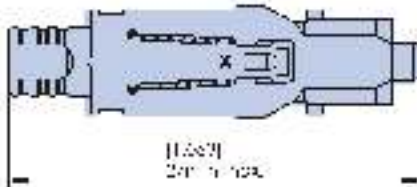

“APC” optical sub-assembly

APC125 singlemode
APC126 singlemode

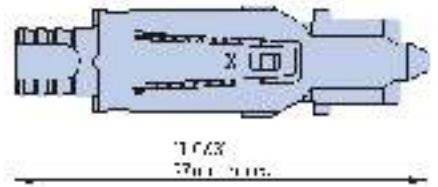

Cable diameter mm	Boots / Accessories (2 of each)	Mechanical dimensions Mm/Inch
0.9 mm		
0.6/1 mm		
0.8/1.6 mm		
2 - 2.4 - 3 mm		

Inside diameter of crimp rings varies according to cable diameter (2, 2.4 or 3 mm).

Rear part of the boot varies according to cable diameter (0.6/1) - (0.8/1.6 ; 2 - 2.4) - (3 mm)

Features



- Alignment sleeve material : zirconia ceramic or phosphor bronze
- Snap-in or flange screw-in mounting
- Color code : Multimode PC : Beige
 Singlemode PC : Blue

Alignment sleeve	Packaging	SC/PC multimode (Beige)	SC/PC singlemode (Blue)	SC/APC singlemode (Green)
Phosphor bronze <i>Snap-in mounting</i>	1	F 728 703 800	F 728 703 200	-
	100	F 728 713 800	F 728 713 200	-
Phosphor bronze <i>Screw-in mounting</i>	1	F 728 700 800	F 728 700 200	-
	100	F 728 710 800	F 728 710 200	-
Zirconia ceramic <i>Snap-in mounting</i>	1	F 728 703 700	F 728 703 000	F 728 703 100
	100	F 728 713 700	F 728 713 000	F 728 713 100
Zirconia ceramic <i>Screw-in mounting</i>	1	F 728 700 700	F 728 700 000	F 728 700 100
	100	F 728 710 700	F 728 710 000	F 728 710 100

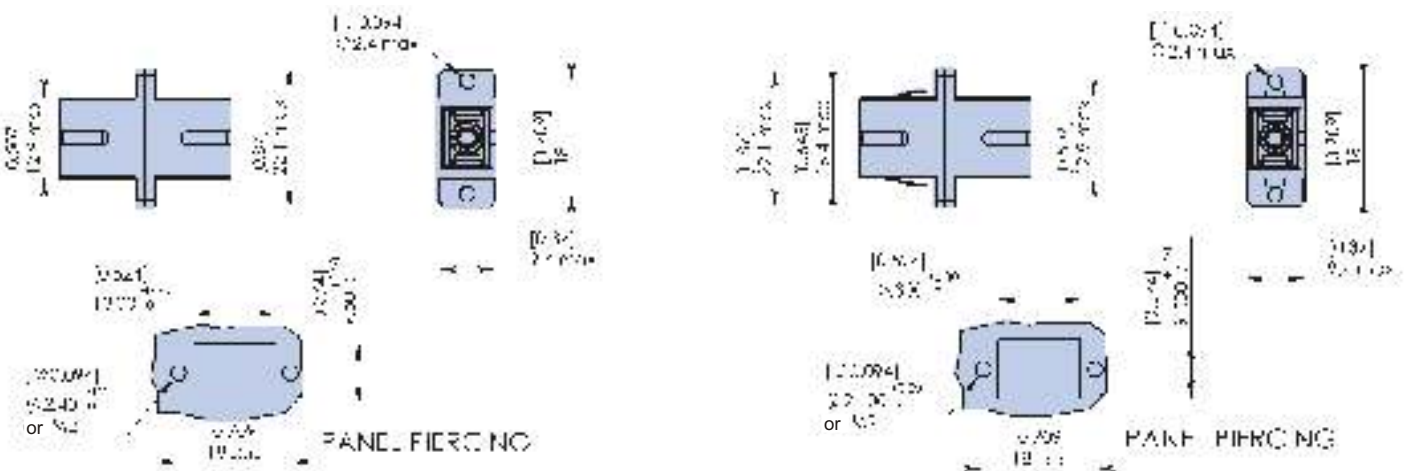

[inches]

Panel clip for simplex adaptor (Bag of 10 clips) : F 718 090 201

Duplex adaptors

Features



- Alignment sleeve material : zirconia ceramic or phosphor bronze
- Snap-in or flange screw-in mounting
- Color code : Multimode PC : Beige
 Singlemode PC : Blue

Alignment sleeve	Packaging	SC/PC multimode (Beige)	SC/PC singlemode (Blue)	SC/APC singlemode (Green)
Phosphor bronze	1	F 728 743 800	F 728 743 200	-
Snap-in mounting	100	F 728 753 800	F 728 753 200	-
Phosphor bronze	1	F 728 740 800	F 728 740 200	-
Screw-in mounting	100	F 728 750 800	F 728 750 200	-
Zirconia ceramic	1	F 728 743 700	F 728 743 000	F 728 743 100
Snap-in mounting	100	F 728 753 700	F 728 753 000	F 728 753 100
Zirconia ceramic	1	F 728 740 700	F 728 740 000	F 728 740 100
Screw-in mounting	100	F 728 750 700	F 728 750 000	F 728 750 100

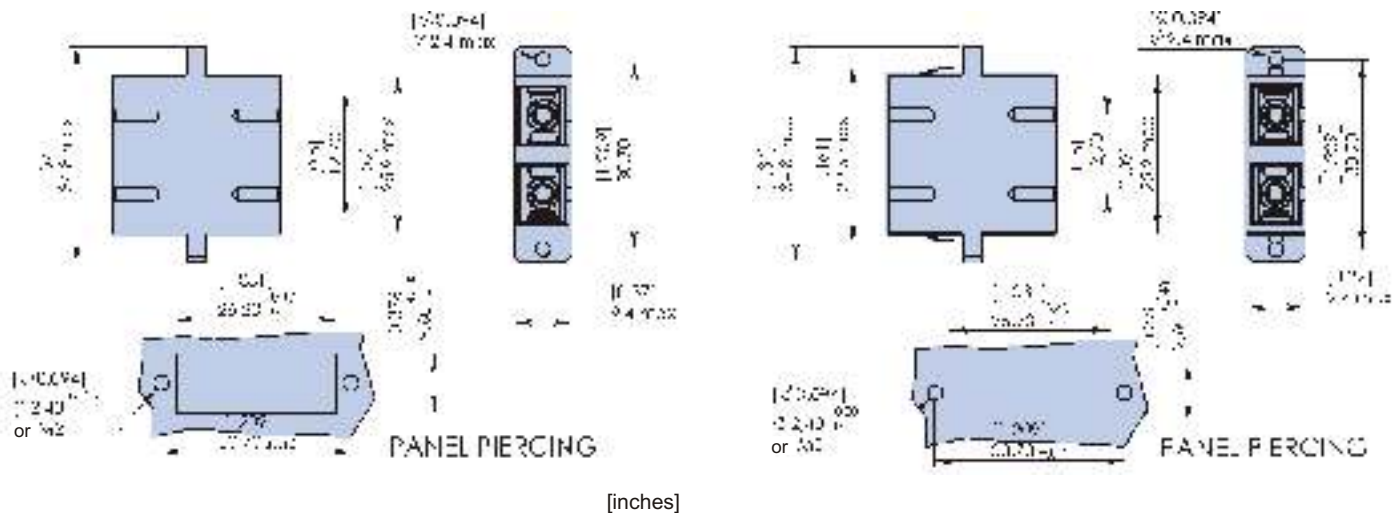

Panel clip for duplex adaptor (Bag of 10 clips) : F 718 091 210

Notes

Note : depending on fiber or cable construction

INSERTION LOSSES

IEC 61300-2-41

	Singlemode PC	Singlemode PC "tuned"	Singlemode APC	Singlemode APC "tuned"	Multimode PC
Attenuation plug mated with reference plug IEC 61300-3-4/1310 and 1550nm/LD					
Mean	<0.20 dB	<0.20dB	<0.20 dB	<0.20 dB	<0.20dB
Standard déviation	0.14 dB	0.14 dB	0.15 dB	0.15 dB	0.08 dB
Peak	<0.8dB,97%	<0.6dB,99%	<0.8dB,97%	<0.6dB,99%	

(1) Attenuation of random mated connectors IEC 61300-3-34

RETURN LOSS

IEC 61300-3-6

Polishing option	Singlemode PC	Singlemode APC	Multimode PC 50/125 & 62.5/125
PC	>30 dB	>60 dB	>20 dB
SPC	>40 dB	-	-

(UPC : automatic polishing machine)

- **Repeatability** 0.10 dB (Maximum loss variation, IEC 61300-2-2)
- **Operating temperature** -40°C/+70°C
- **Storage temperature** -40°C/+85°
- **Cable traction** 0.9mm and tube : 10N
2 to 3mm cable : 100N
- **Mechanical endurance** 500 matings

APPLICATIONS

- Telecommunication networks (SONET/ATM)
- Broadband subscriber networks
- Fiber Management Systems
- Active device termination

Features



- Screw thread coupling
- One-piece Tunable connector (adjustable to 6 positions)
- "N" keyed type
- Pull proof
- "PC" pre-radius (20mm) zirconia ceramic ferrule
- "APC" pencil zirconia ceramic ferrule
- Secure crimping (double ferrule)
- Secure bonding
- Cable range : 0.9 to 3mm, tight or semi-loose structure
- Boots color code : yellow boot in singlemode PC
Black boot in multimode PC

Cable diameter (mm)	Packaging	PC125 Singlemode	PC126 Singlemode	PC128 multimode	PC230 multimode	APC125 singlemode	APC126 Singlemode
Level "zero" (1)	100	F 729 101 000	F 729 102 000	F 729 103 000	-	F 729 111 000	F 729 112 000
0.9 (Buffer)	1	F 729 001 100	F 729 002 100	F 729 003 100	-	F 729 011 100	F 729 012 100
0.9 (Buffer)	100	F 729 101 100	F 729 102 100	F 729 103 100	-	F 729 111 100	F 729 112 100
0.6/1 (tube)	1	F 729 001 200	F 729 002 200	-	-	-	-
0.6/1 (tube)	100	F 729 101 200	F 729 102 200	-	-	-	-
0.8/1.6 (tube)	1	F 729 001 300	F 729 002 300	-	-	-	-
0.8/1.6 (tube)	100	F 729 101 300	F 729 102 300	-	-	-	-
1.6	1	F 729 001 400	F 729 002 400	F 729 003 400	-	F 729 011 400	F 729 012 400
1.6	100	F 729 101 400	F 729 102 400	F 729 103 400	-	F 729 111 400	F 729 112 400
2	1	F 729 001 500	F 729 002 500	F 729 003 500	-	F 729 011 500	F 729 012 500
2	100	F 729 101 500	F 729 102 500	F 729 103 500	-	F 729 111 500	F 729 112 500
2.4	1	F 729 001 600	F 729 002 600	F 729 003 600	-	F 729 011 600	F 729 012 600
2.4	100	F 729 101 600	F 729 102 600	F 729 103 600	-	F 729 111 600	F 729 112 600
3	1	F 729 001 700	F 729 002 700	F 729 003 700	F 729 005 700	F 729 011 700	F 729 012 700
3	100	F 729 101 700	F 729 102 700	F 729 103 700	F 729 105 700	F 729 111 700	F 729 112 700

(1) the level "zero" is supplied without boots or crimp sleeves and allows the user to manage his cable diameters, colour of boots, etc... According to the situation.

All accessories (boots, crimp sleeves, etc...) can be ordered separately. These accessories are common to SC and FC. See page 31 for part numbers.

Connector body

PC125 pigtailed mode
PC125 single mode
PC128 multimode

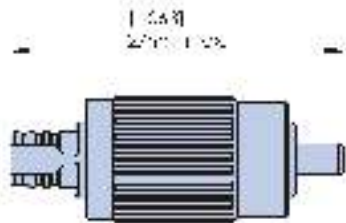

[inches]

1.531 inches
27mm (1.063 inches)

Connector body

APC125 pigtailed mode
APC125 single mode

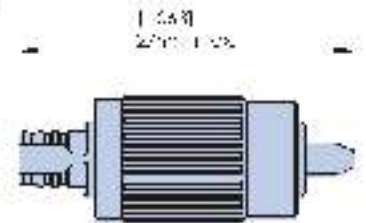

1.531 inches
27mm (1.063 inches)

Cable diameter mm	Boots / Accessories	Mechanical dimensions Mm/Inch
0.9 mm		
0.6/1 mm		
0.8/1.6 mm		
2 - 2.4 - 3 mm		

Inside diameter of crimp rings varies according to cable diameter (2, 2.4 or 3 mm).

Rear part of the boot varies according to cable diameter (0.6/1) - (0.8/1.6 ; 2 - 2.4) - (3 mm)

Features



- Alignment sleeve material : zirconia ceramic or phosphor bronze
- "N" keyed type and "R" type available
- 3 versions available : square flange
 - "D" hole standard 9mm
 - "D" hole compact 8mm.
- Screw threaded coupling

	Alignment sleeve	Packaging	Part numbers	
			Keyed "N"	Keyed "R"
Square flange	Zirconia ceramic	1	F 729 701 000	F 729 701 110
		100	F 729 711 000	F 729 711 110
	Phosphor bronze	1	F 729 701 200	-
		100	F 729 711 200	-
"D" hole standard 9mm Supplied with lock washer and nut for panel mounting	Zirconia ceramic	1	F 729 708 000	F 729 708 110
		100	F 729 718 000	F 729 718 110
	Phosphor bronze	1	F 729 708 200	-
		100	F 729 718 200	-
"D" hole compact 8mm Supplied with lock washer and nut for panel mounting	Zirconia ceramic	1	F 729 702 000	F 729 702 110
		100	F 729 712 000	F 729 712 110
	Phosphor bronze	1	F 729 702 200	-
		100	F 729 712 200	-

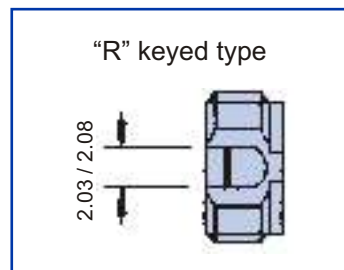
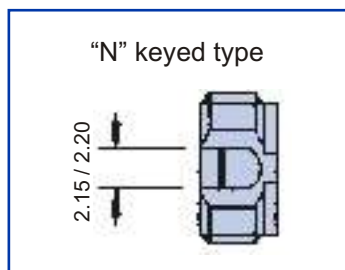

Note : FC connector type N can be inserted into only adaptors of type "N".

Dimensions (mm)

Square flange

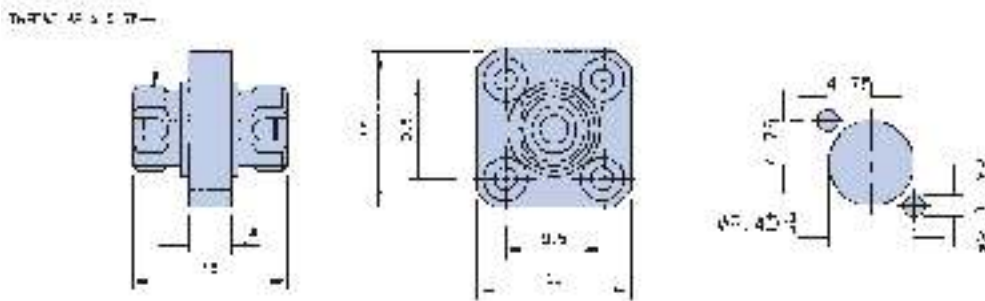

“D” hole 9 mm

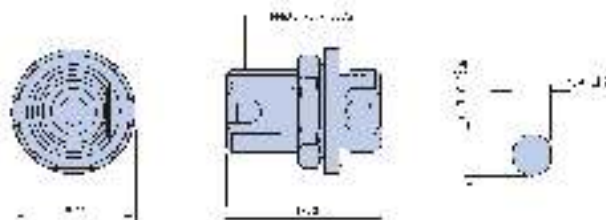
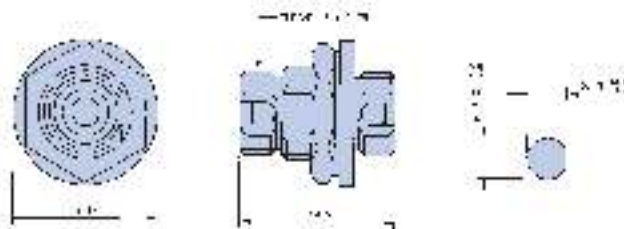

mm to inch : 0.03937

Note : depending on fiber or cable construction

INSERTION LOSSES

	Singlemode (9/125) 1300nm	Multimode (62.5/125) 850nm
IEC 1300-3-4, method B or CECC 86000, method 7		
Typical	<0.25dB	<0.25dB
Standard deviation	0.11dB	0.11dB

RETURN LOSS

Polishing	Singlemode PC	Multimode PC (50/125 & 62.5/125)
IEC 61300-3-6 , method B or CECC 86000, method 3, OTDR		
PC	>30 dB	>30 dB
SPC	>40 dB	-
UPC	>50 dB	-

- **Repeatability** 0.10 dB (Maximum loss variation, IEC 61300-2-2)
- **Operating temperature** -40°C/+70°C
- **Storage temperature** -40°C/+85°C
- **Traction**
 - Fiber retention : 5N
 - Tube or coating retention : 10N
 - Cable retention : 100N
 - Jacket retention : 10N (for secure crimping version)

APPLICATIONS

- Data communications
- Local area networks
- Instrumentation

Features



- Bayonet locking system
- Pre-radius (20mm) zirconia ceramic ferrule
- Standard or Secure crimping (double ferrule)
- Cable range : all diameters covered from 0.9 to 3mm.
- Metal body

ST I style

Cable diameter (Mm)	Ceramic ferrule size	Description	Packaging	
			1	100
Level "zero" (1)	128 multimode	Connector body.	-	F 709 029 200
0.9, 1.1 and 3mm (universal : tube and cable)	128 multimode	Connector body, 2 black boots, crimp ferrule.	F 709 028 000	F 709 028 200

ST II style, standard crimping.

Cable diameter (mm)	Ceramic ferrule size	Description	Packaging	
			1	100
Level "zero" (1)	128 multimode	Connector body.	F 709 025 000	F 709 025 200
0.9mm (coated fiber) 1.1mm (tube)	128 multimode	Connector body, black boot.	F 709 022 000	F 709 022 200
1.6mm (cable)	128 multimode	Connector body, black boot	F 709 093 000	-
2.7 to 3mm (cable)	128 multimode	Connector body, black boot, crimp ferrule...	F 709 023 000	F 709 023 200
2.7 to 3mm (cable)	128 multimode	Connector body, red boot, crimp ferrule.	F 709 023 204	F 709 023 205
0.9, 1.1 and 3mm (Universal : tube and cable)	128 multimode	Connector Body, 2 black boots, crimp ferrule.	F 709 024 000	F 709 024 200
0.9, 1.1 and 3mm (Universal : tube and cable)	140 multimode	Connector Body, 2 black boots, crimp ferrule	F 709 090 000	-
2.7 to 3mm (cable)	230 multimode	Connector body, black boot, crimp ferrule.	F 709 038 000	-
Level "zero" (1)	125 singlemode	Connector body.	-	F 709 037 200
Level "zero" (1)	126 singlemode	Connector body.	-	F 709 036 200
0.9, 1.1 and 3mm (Universal : tube and câble)	126 singlemode	Connector Body, 2 black boots, crimp ferrule	F 709 034 706	F 709 034 200
1.6mm (cable)	126 singlemode	Connector body, black boot, crimp ferrule	F 709 094 000	-

Note 1 - The level "zero" is supplied without boots or crimp sleeves and allows the user to manage his cable diameters, colour of boots, etc...

All accessories (boots, crimp sleeves, etc...) can be ordered separately. See page 31 for part numbers.

ST I - Dimensions (mm)

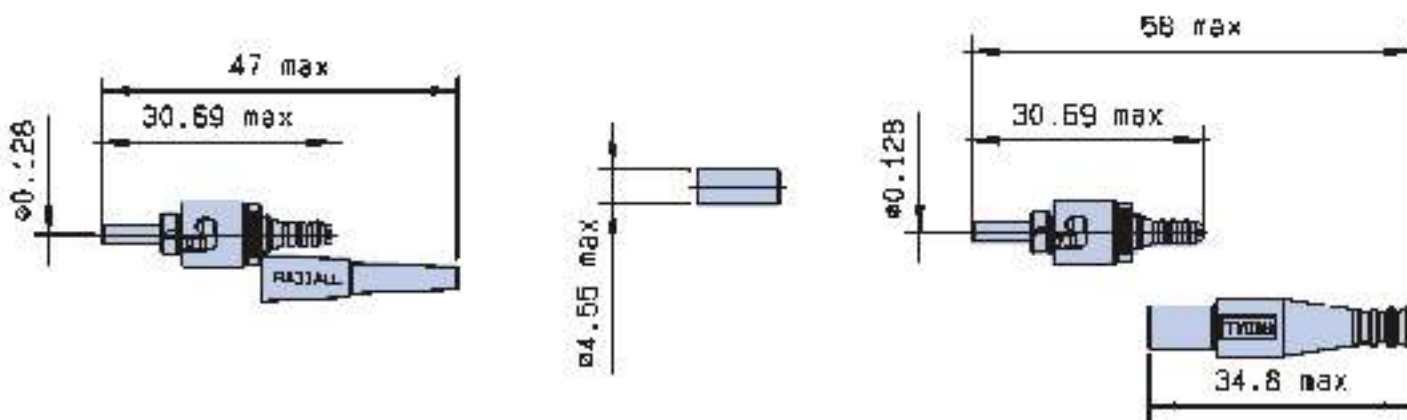

ST II - Dimensions (mm)

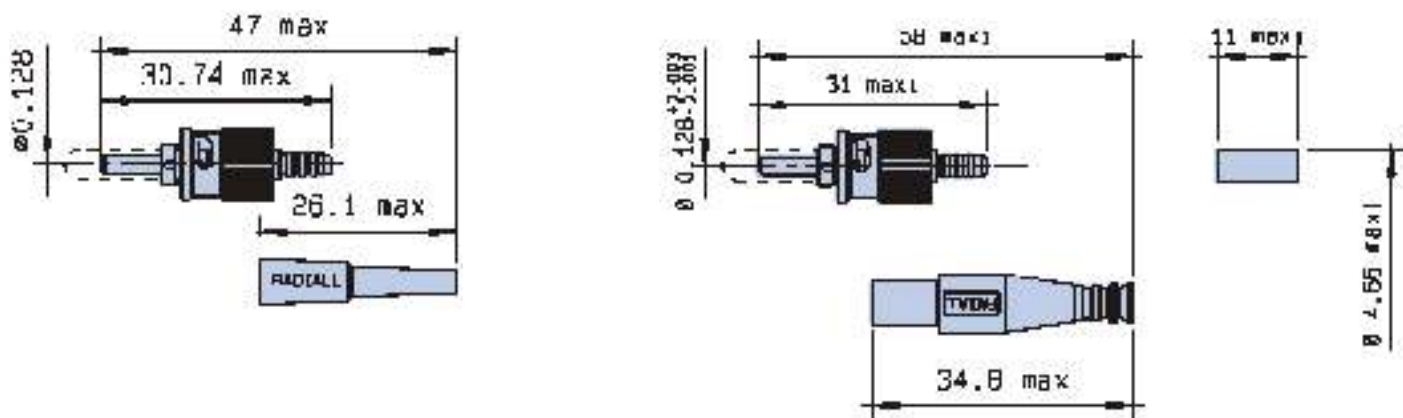

mm to inch : 0.03937

ST II style, secure crimping

Cable diameter (mm)	Ceramic ferrule size	Description	Packaging	
			1	100
2 to 2.2mm (cable)	128 multimode	Connector body, black boot, crimp ferrule	F 709 097 000	F 709 097 200
2.5mm (cable)	128 multimode	Connector body, black boot, crimp ferrule	F 709 099 000	F 709 099 200
2.7 to 3mm (cable)	128 multimode	Connector body, black boot, crimp ferrule	F 709 098 000	F 709 098 200
2 to 2.2mm (cable)	126 singlemode	Connector Body, black boot, crimp ferrule.	F 709 095 000	F 709 095 200
2.7 to 3mm (cable)	126 singlemode	Connector body, black boot, crimp ferrule.	F 709 096 000	F 709 096 200

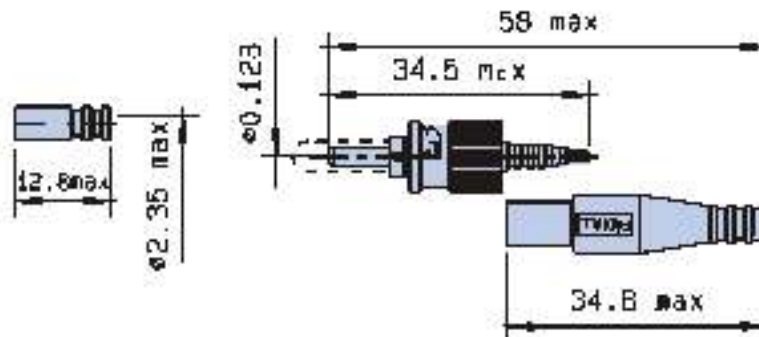

Dimensions in mm

BeST Fully floating ferrule connector



The beST patented design overcomes the problem of the dependence of optical performance on applied cable loads. It provides highest quality and performance to both multimode and singlemode applications. Secure crimping option.

For tight jacket cable.

Cable diameter (mm)	Ceramic ferrule size	Description	Packaging unit
2.7 to 3.5 mm	128 multimode	Connector body, grey boot, crimp ferrule	F 709 054 000
2.7 to 3.5 mm	125 singlemode	Connector body, grey boot, crimp ferrule	F 709 070 705
2.7 to 3.5 mm	126 singlemode	Connector body, grey boot, crimp ferrule	F 709 070 706

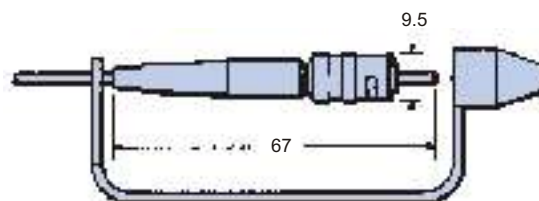

Dimensions in mm

mm to inch : 0.03937

ST sealed connector for outside application



- Effective protection against harsh environment
- Bayonet locking system
- Pre-radius multimode (20mm) zirconia ceramic ferrule
- Secure crimping
- An outside boot provides the sealing of the complete connection : plug and adaptor.

The panel sealing is provided by an internal gasket on the bulkhead adaptor.



The sealing is guaranteed on 3 points of the connection : panel/adaptor, connector/adaptor, connector/cable.



Cable dia.	Ceramic ferrule size	Description	Part number
2.7 to 3mm Consult us for other dimensions	128 multimode	Connector body, standard boot, sealed boot, crimp ring.	F 709 089 000

To be used with sealing adaptor F 709 724 000. See page 28.

Features



- Metal body
- Alignment sleeve material : zirconia ceramic or phosphor bronze
- Bayonet coupling
- Available in standard and sealed version for outside applications.

Standard version

Alignment sleeve	Packaging	Part numbers
Singlemode zirconia ceramic	1	F 709 730 000
	100	F 709 730 200
Multimode zirconia ceramic	1	F 709 725 000
	100	F 709 725 200
Phosphor bronze	1	F 709 722 000
	100	F 709 722 200

Dimensions in mm

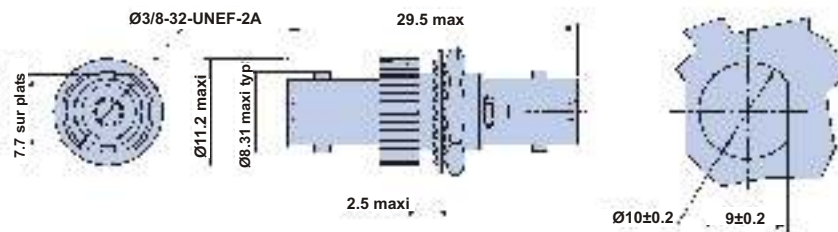

Panel piercing

Sealed version

Alignment sleeve	Packaging	Part number
Phosphor bronze	1	F 709 724 000

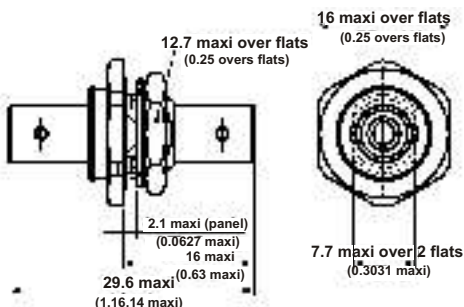

mm to inch : 0.03937

Features



- Metal body
- Bulkhead or PCB mounting

Bulkhead or PCB mounting

F 709 400 000

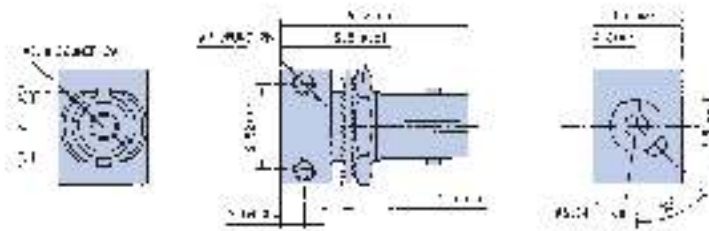

Bulkhead mounting

F 709 401 000

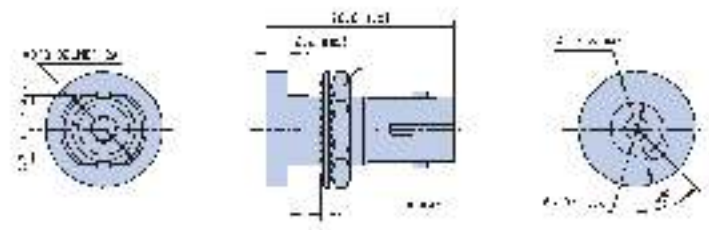

Dimensions in mm
mm to inch : 0.03937

NOTES

Accessories

Boots: SC, FC, ST

Bag of 100 boots.

Cable dia.	BLUE	BEIGE	BLACK	GREEN	YELLOW	RED
1mm max. SC/FC	F 718 105 201	F 718 105 206	F 718 105 200	F 718 105 205	F 718 105 202	F 718 105 203
1mm max. ST	-	-	F 718 064 000	F 718 107 202	-	-
2 to 2.4mm max. SC/FC/ST	F 718 104 201	F 718 104 206	F 718 104 200	F 718 104 205	F 718 104 202	F 718 104 203
2.7 to 3 mm max. SC/FC/ST	F 718 103 201	F 718 103 206	F 718 103 200	F 718 103 205	F 718 103 202	F 718 103 203

Other sizes : please consult Radiall



Inner sleeve for 1.6 to 3mm cable, SC, FC

Bag of 100

F 718 106 200



Crimp rings :

Bag of 100

Crimp ring for 2 mm cable, SC/FC	F 718 109 200
Crimp ring for 2.4 mm cable, SC/FC	F 718 108 200
Crimp ring for 2.7/3 mm cable, SC/FC	F 718 107 200
Crimp ring for 2.7/3 mm cable, ST	F 718 069 000



Safety cap for ST and FC connectors

Bag of 20

F 718 044 000



Metal protective cap for ST connectors

F 709 750 000



Metal protective cap for ST adaptors and device housing receptables

F 709 760 000



Metal dust cap for FC adaptor.

F 729 802 000



Universal, plastic dust cap. For all 2.5mm optical ferrule. Bag of 20.

F 718 111 220

Termination tooling



The tooling is composed of a basic kit containing all the tools common to the ST, SC, FC series. The toolings specific to each series should be ordered separately.

BASIC KIT in 220V	Reference F 780 844 000
BASIC KIT in 110V	Reference F 780 845 000

Supplied with assembly procedure.

Content of the basic KIT :

	Qty	Tools	P/N
	1	Curing oven 220V	F 780 463 000
	1	Or : Curing oven 110V	F 780 464 000
	1	"No-Nik" buffer stripper (for 250 µm)	F 780 026 000
	1	"X-Cellite" outer jacket stripper (for cable 2.8mm)	F 780 037 000
	1	"Miller" primary stripper (for coating 900µm)	F 780 025 000
consumable	1	Bag of 10 polishing 0.3 µm films	F 780 827 000
consumable	2	Bag of 10 polishing 1 µm films	F 780 826 000
consumable	1	Bag of 10 polishing 3 µm films	F 780 825 000
consumable	1	Bag of 10 abrasive strips 12µm	F 780 508 000
	1	Soft rubber polishing base	F 780 812 000
consumable	1	Bottle of abrasive solution	F 780 318 000
consumable	1	6 bags of epoxy resin OE184	F 780 242 000
consumable	1	Bag of 5 Syringes for ST connector	F 780 243 000
consumable	1	Bag of 5 Syringes for FC / SC connectors	F 780 219 000
	1	Ceramic Scoring blade	F 780 136 000
	1	Microscope X100	F 780 233 000
	1	Ceramic scissors	F 780 039 000
	1	Solvent dispenser	F 780 809 000
consumable	1	Set of cleaning papers	F 780 527 000
consumable	1	Set of 50 Cleaning tips	F 780 584 000

Others :Ruler, Tweezers, adhesive paper, containers for resin preparation, cable / fiber preparation template, thermometer.

SC/FC consumable kit	F 780 583 000
10 polishing films (0.3µm) 20 polishing films (1 µm) 4 polishing films (3 µm) 2 abrasive strips (12 µm) 4 bags of resin OE184 4syringes 2 cleaning paper sets	

The referenced products can be ordered separately.

SC/FC/ST Cleaning kit	F 780 585 000
50cleaning tips Cleaningpaper Adhesive Roll Bottlefor alcohol	

Optional tools	P/N
Crimp tool > FC and SC	F 780 051 000
Crimp tool > ST	F 780 052 000
Polishing tool > FC/PC	F 780 840 000
Polishing tool > SC/PC	F 780 590 000
Polishing tool > ST	F 780 801 000

The quantity of consumables delivered in this kit permits the assembly of 100 connectors.

Tuning tool for SC/FC connectors



The tuning technique consists of rotating the optical ferrule to locate the core in a pre-determined permanent sector, thus reducing the off-set between fibre cores (IEC 61300-2-41).

Thanks to its 6 possible positions, the Radiall concept provides a more accurate tuning.

For this technique, a precision tuning tool has been developed.

The tool is very user-friendly and allows operating times to be cut significantly. It is also very reliable : six locking points are adjusted and secured in the factory. There is no risk to the fiber as the optical faces are separated during the tuning operation. This is a unique aspect of the Radiall tool.

The tuning kit includes an adjustment patchcord terminated with a FC connector

A zirconia sleeve mounted on the adjustment plug ensures that the optical ferrules are correctly aligned within the tool. This sleeve is mobile and can be easily replaced by the user.

"PC" and "APC" connectors can be tuned.

With this new concept, optimization at any time, of any standard cable assembly using RADIALL SC F728 and FC F729 connectors now becomes possible.

SC Tuning Kit	FC Tuning Kit
F 780 600 000	F780 601 000

Supplied with processing instructions.

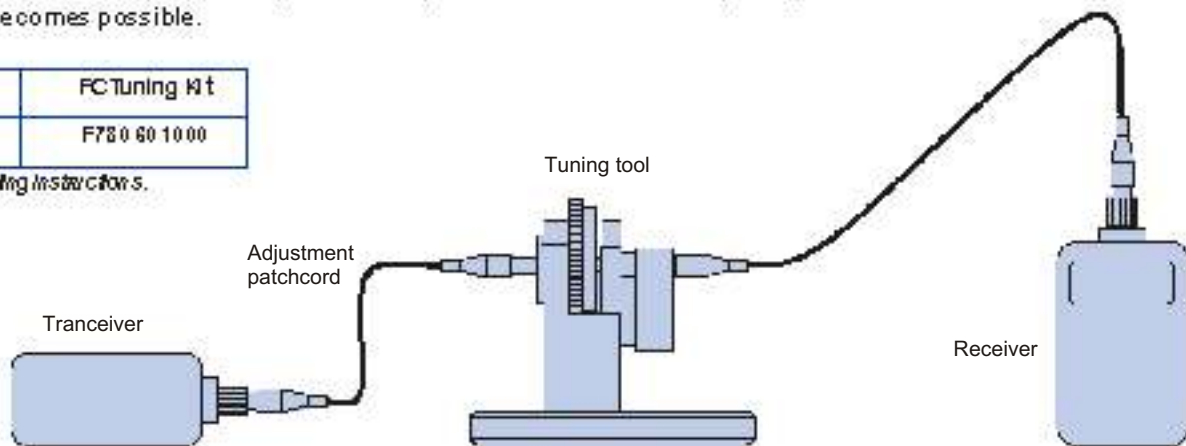

Kit Contents

Qty	Description	P/T
1	Tuning tool (SC or FC)	-
2	Adjustment patchcord	F 780 610 000
2	Bag of 6 zirconia alignment sleeves	F 718 113 206
1	Bag of 50 cleaning tips	F 780 584 000
1	Book of 6 cleaning paper	F 780 527 000
1	SC housing removal tool (into the SC kit only)	F 780 582 000
1	Patchcord removal tool	-

All codified parts can be ordered separately.

Type	Panel mounting	alignment sleeve	P/N
------	----------------	------------------	-----

FC/SC simplex

All plastic body

Body color : blue	Screw-in	ph/br	F 719 017 000
		zirconia	F 719 018 000
Body color : beige	Screw-in	ph/br	F 719 019 000
		zirconia	F 719 020 000
Body color : green (APC)	Screw-in	zirconia	F 719 022 000



FC metal/SC plastic

SC color body : blue	Screw-in	ph/br	F 719 039 000
		zirconia	F 719 042 000
SC color body : beige	Screw-in	ph/br	F 719 040 000
		zirconia	F 719 043 000



all metal body

Body color : metalized	Screw-in	zirconia	F 719 024 000
------------------------	----------	----------	---------------



FC/SC duplex

FC metal/SC plastic

SC body color : blue	Screw-in	ph/br	F 719 033 000
		zirconia	F 719 036 000
SC body color : beige	Screw-in	ph/br	F 719 034 000
		zirconia	F 719 037 000



FC/ST simplex

All metal body

Body color : metalized	Screw-in	ph/br	F 719 049 000
		zirconia	F 719 050 000



Dimensions in mm mm to inch : 0.03937

Inter-series adaptors

Type	Panel mounting	alignment sleeve	P/N
------	----------------	------------------	-----

SC/ST simplex

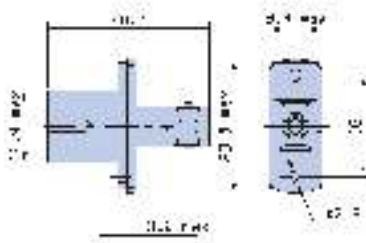

ST metal/SC plastic

SC color body : blue	Screw-in	ph/br	F 719 025 000
		zirconia	F 719 027 000
SC color body : beige	Screw-in	ph/br	F 719 026 000
		zirconia	F 719 028 000



All metal body

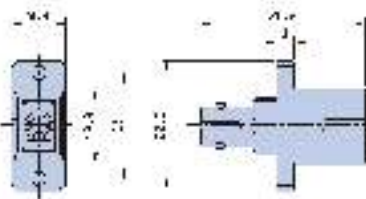

Body color : metallized	nut	zirconia	F 719 023 000
-------------------------	-----	----------	---------------



SC/ST duplex

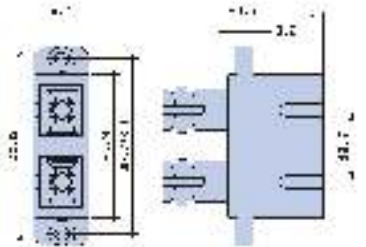

ST metal/SC plastic

SC color body : blue	Screw-in	ph/br	F 719 029 000
		zirconia	F 719 031 000
SC color body : beige	Screw-in	ph/br	F 719 030 000
		zirconia	F 719 032 000



SC Panel clip (Bag of 10 clips) :
 F 718 090 201 Simplex version
 F 718 091 210 Duplex version

Dimensions in mm
 mm to inch : 0.03937

Numerical index

Part Number	Page	Part Number	Page	Part Number	Page
F 709 022 000	24	F 718 103 205	31	F 728 011 100	10
F 709 022 200	24	F 718 103 206	31	F 728 011 500	10
F 709 023 000	24	F 718 104 200	31	F 728 011 600	10
F 709 023 200	24	F 718 104 201	31	F 728 011 700	10
F 709 023 204	24	F 718 104 202	31	F 728 012 100	10
F 709 023 205	24	F 718 104 203	31	F 728 012 500	10
F 709 024 000	24	F 718 104 205	31	F 728 012 600	10
F 709 024 200	24	F 718 104 206	31	F 728 012 700	10
F 709 025 000	24	F 718 105 200	31	F 728 101 000	10
F 709 025 200	24	F 718 105 201	31	F 728 101 100	10
F 709 028 000	24	F 718 105 202	31	F 728 101 200	10
F 709 028 200	24	F 718 105 203	31	F 728 101 300	10
F 709 029 200	24	F 718 105 205	31	F 728 101 500	10
F 709 034 200	24	F 718 105 206	31	F 728 101 600	10
F 709 034 706	24	F 718 106 200	31	F 728 101 700	10
F 709 036 200	24	F 718 107 200	31	F 728 102 000	10
F 709 037 200	24	F 718 107 202	31	F 728 102 100	10
F 709 038 000	24	F 718 108 200	31	F 728 102 200	10
F 709 054 000	26	F 718 109 200	31	F 728 102 300	10
F 709 070 705	26			F 728 102 500	10
F 709 070 706	26	F 719 017 000	34	F 728 102 600	10
F 709 089 000	27	F 719 018 000	34	F 728 102 700	10
F 709 090 000	24	F 719 019 000	34	F 728 103 000	10
F 709 093 000	24	F 719 020 000	34	F 728 103 100	10
F 709 094 000	24	F 719 022 000	34	F 728 103 500	10
F 709 095 000	26	F 719 023 000	35	F 728 103 600	10
F 709 095 200	26	F 719 024 000	34	F 728 103 700	10
F 709 096 000	26	F 719 025 000	35	F 728 105 700	10
F 709 096 200	26	F 719 026 000	35	F 728 111 000	10
F 709 097 000	26	F 719 027 000	35	F 728 111 100	10
F 709 097 200	26	F 719 028 000	35	F 728 111 500	10
F 709 098 000	26	F 719 029 000	35	F 728 111 600	10
F 709 098 200	26	F 719 030 000	35	F 728 111 700	10
F 709 099 000	26	F 719 031 000	35	F 728 112 000	10
F 709 099 200	26	F 719 032 000	35	F 728 112 100	10
F 709 400 000	29	F 719 033 000	34	F 728 112 500	10
F 709 401 000	29	F 719 034 000	34	F 728 112 600	10
F 709 722 000	28	F 719 036 000	34	F 728 112 700	10
F 709 722 200	28	F 719 037 000	34	F 728 401 100	12
F 709 724 000	28	F 719 039 000	34	F 728 401 200	12
F 709 725 000	28	F 719 040 000	34	F 728 401 300	12
F 709 725 200	28	F 719 042 000	34	F 728 401 500	12
F 709 730 000	28	F 719 043 000	34	F 728 401 600	12
F 709 730 200	28	F 719 049 000	34	F 728 401 700	12
F 709 750 000	31	F 719 050 000	34	F 728 402 100	12
F 709 760 000	31			F 728 402 200	12
		F 728 001 100	10	F 728 402 300	12
F 711 200 000	22	F 728 001 200	10	F 728 402 500	12
F 711 400 000	22	F 728 001 300	10	F 728 402 600	12
F 711 401 000	22	F 728 001 500	10	F 728 402 700	12
		F 728 001 600	10	F 728 403 100	12
F 718 044 000	31	F 728 001 700	10	F 728 403 500	12
F 718 064 000	31	F 728 002 100	10	F 728 403 600	12
F 718 069 000	31	F 728 002 200	10	F 728 403 700	12
F 718 090 201	14-35	F 728 002 300	10	F 728 411 100	12
F 718 091 210	15-35	F 728 002 500	10	F 728 411 500	12
F 718 100 000	12	F 728 002 600	10	F 728 411 600	12
F 718 101 000	12	F 728 002 700	10	F 728 411 700	12
F 718 102 000	12	F 728 003 100	10	F 728 412 100	12
F 718 103 200	31	F 728 003 500	10	F 728 412 500	12
F 718 103 201	31	F 728 003 600	10	F 728 412 600	12
F 718 103 202	31	F 728 003 700	10	F 728 412 700	12
F 718 103 203	31	F 728 005 700	10	F 728 501 100	12

Numerical index

Part Number	Page	Part Number	Page	Part Number	Page
F 728 501 200	12	F 729 001 100	18	F 729 708 200	20
F 728 501 300	12	F 729 001 200	18	F 729 711 000	20
F 728 501 500	12	F 729 001 300	18	F 729 711 110	20
F 728 501 600	12	F 729 001 500	18	F 729 711 200	20
F 728 501 700	12	F 729 001 600	18	F 729 712 000	20
F 728 502 100	12	F 729 001 700	18	F 729 712 110	20
F 728 502 200	12	F 729 002 100	18	F 729 712 200	20
F 728 502 300	12	F 729 002 200	18	F 729 718 000	20
F 728 502 500	12	F 729 002 300	18	F 729 718 110	20
F 728 502 600	12	F 729 002 500	18	F 729 718 200	20
F 728 502 700	12	F 729 002 600	18		
F 728 503 100	12	F 729 002 700	18	F 780 025 000	32
F 728 503 500	12	F 729 003 000	18	F 780 026 000	32
F 728 503 600	12	F 729 003 100	18	F 780 037 000	32
F 728 503 700	12	F 729 003 500	18	F 780 039 000	32
F 728 511 100	12	F 729 003 600	18	F 780 051 000	32
F 728 511 500	12	F 729 003 700	18	F 780 052 000	32
F 728 511 600	12	F 729 005 700	18	F 780 113 206	33
F 728 511 700	12	F 729 011 100	18	F 780 136 000	32
F 728 512 100	12	F 729 011 500	18	F 780 219 000	32
F 728 512 500	12	F 729 011 600	18	F 780 233 000	32
F 728 512 600	12	F 729 011 700	18	F 780 242 000	32
F 728 512 700	12	F 729 012 100	18	F 780 243 000	32
F 728 700 000	14	F 729 012 500	18	F 780 318 000	32
F 728 700 100	14	F 729 012 600	18	F 780 463 000	32
F 728 700 200	14	F 729 012 700	18	F 780 464 000	32
F 728 700 700	14	F 729 101 000	18	F 780 508 000	32
F 728 700 800	14	F 729 101 100	18	F 780 527 000	32-33
F 728 703 000	14	F 729 101 200	18	F 780 582 000	33
F 728 703 100	14	F 729 101 300	18	F 780 583 000	32
F 728 703 200	14	F 729 101 500	18	F 780 584 000	32-33
F 728 703 700	14	F 729 101 600	18	F 780 590 000	32
F 728 703 800	14	F 729 101 700	18	F 780 600 000	33
F 728 710 000	14	F 729 102 000	18	F 780 601 000	33
F 728 710 100	14	F 729 102 100	18	F 780 610 000	33
F 728 710 200	14	F 729 102 200	18	F 780 801 000	32
F 728 710 700	14	F 729 102 300	18	F 780 809 000	32
F 728 710 800	14	F 729 102 500	18	F 780 811 000	32
F 728 713 000	14	F 729 102 600	18	F 780 812 000	32
F 728 713 100	14	F 729 102 700	18	F 780 825 000	32
F 728 713 200	14	F 729 103 100	18	F 780 826 000	32
F 728 713 700	14	F 729 103 500	18	F 780 827 000	32
F 728 713 800	14	F 729 103 600	18	F 780 840 000	32
F 728 740 000	15	F 729 103 700	18	F 780 844 000	32
F 728 740 100	15	F 729 105 700	18	F 780 845 000	32
F 728 740 200	15	F 729 111 000	18		
F 728 740 700	15	F 729 111 100	18		
F 728 740 800	15	F 729 111 500	18		
F 728 743 000	15	F 729 111 600	18		
F 728 743 100	15	F 729 111 700	18		
F 728 743 200	15	F 729 112 000	18		
F 728 743 700	15	F 729 112 100	18		
F 728 743 800	15	F 729 112 500	18		
F 728 750 000	15	F 729 112 600	18		
F 728 750 100	15	F 729 112 700	18		
F 728 750 200	15	F 729 701 000	20		
F 728 750 700	15	F 729 701 110	20		
F 728 750 800	15	F 729 701 200	20		
F 728 753 000	15	F 729 702 000	20		
F 728 753 100	15	F 729 702 200	20		
F 728 753 200	15	F 729 708 000	20		
F 728 753 700	15	F 729 708 110	20		
F 728 753 800	15				

NEW PRODUCT INFORMATION

LC series F727

RADIALL completes its range of fiber optic components with the introduction of the LC : a High Density Fiber Optic Connector Solution for small form factor applications.

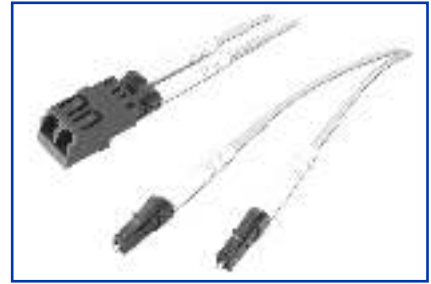

The LC benefits from an RJ-45 latching system and panel cutout. Radiall provides a standard range of connectors, adaptors and cable assembly products.

Connectors are available for both singlemode and multimode applications, for 900 microns buffered fibre and 1.6 up to 2mm ruggedised cables.

PIGTAILING

The extensive knowledge of optical components, material technology and fiber termination processes enable Radiall to manufacture a range of assembly products, fiber pigtailed to customer specific products.

> Fiber Forming

Ceramic, Metal, Glass & Plastic Ferrule polishing. Metal Injection Molded Components. Fiber Metalization. Fiber Cleaving. Fiber Splicing. Fiber Etching. Fiber Lensing. Ribbon " V " bloc mounts. Ribbon Fiber Fan Outs.

Please contact your Sales Office for all information.

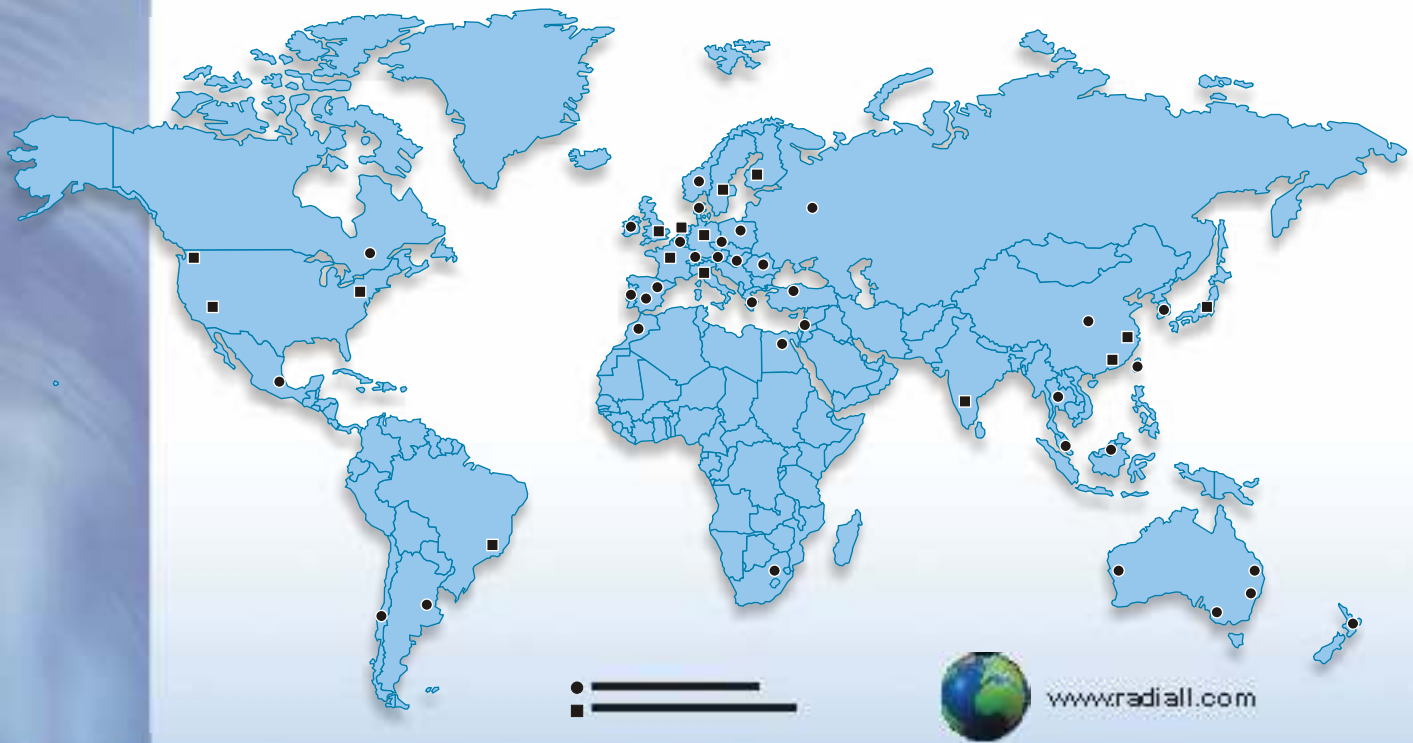

RADIALL WORLDWIDE LOCATIONS

EUROPE

France - RADIALL HEADQUARTERS

101, Rue Ph. Hoffmann - 93116 ROSNY sous BOIS (Paris)
Tel. : +33 1 49 35 35 35 Fax : +33 1 48 54 63 63
E-Mail : export@radiall.fr

Finland - RADIALL S.F.

Pakilantie 61 - FIN-00660 HELSINKI
Tel. : +358 9 34 89 657 Fax : +358 9 34 89 358
E-Mail : info@radiall.fi

Germany - RADIALL G.m.b.H.

CarlZeiss Str. Postfach 200143 - D63307 RÖDERMARK (Frankfurt)
Tel. : +49 6 074 910 70 Fax : +49 6 074 910 770
E-Mail : info@radiall.de
Regional offices : Berlin - Hamburg - Munich

Italy - RADIALL Elettronica S.R.L.

Via Concordia, 5 - I20090 ASSAGO MILANO
Tel. : +39 02 48 85 121 Fax : +39 02 48 84 30 38
E-Mail : radiall@tin.it
Regional office : Roma

Netherlands - RADIALL B.V.

Postbus 64 - 3870 CB HOEVELAKEN
Tel. : +31 33 253 40 09 Fax : +31 33 253 45 12
E-Mail : info@radiall.nl

Sweden - RADIALL A.B.

Box 6061 Sjöängsvägen 2 - S19272 SOLLENTUNA (Stockholm)
Tel. : +46 8 444 34 10 Fax : +46 8 754 49 16
E-Mail : info@radiall.se

U.K. - RADIALL Ltd

10, Perivale Industrial Park, Horsenden Lane south
PERIVALE Middlesex UB6 7RL (London)
Tel. : +44 20 8991 7700 Fax : +44 20 8991 7769
E-Mail : info@radiall.co.uk

AMERICA

USA - RADIALL, INC.

RF Coaxial connectors, Microwave devices & Fiber optic connectors
260 Hathaway Drive - STRATFORD Connecticut 06615
Tel. : +1 203 380 9800 Fax : +1 888 387 0001
E-Mail : sales@radiallusa.com

USA - RADIALL LARSEN Antenna Technologies, INC

Antennas
3611 NE 112th Avenue - VANCOUVER, Washington 98682
Tel. : +1 360 944 7551 Fax : +1 360 944 7556
E-Mail : info@radialllarsen.com

USA - RADIALL JERRIK, INC.

Multipin connectors & Filtered connectors
102 West Julie Drive - TEMPE, Arizona 85283 (Phoenix)
Tel. : +1 480 730 5700 Fax : +1 480 730 5800
E-Mail : sales@radialljerrik.com

Brasil - RADIALL do Brasil

Av. Beira Mar, 262 6^o - Castello 20021060 RIO DE JANEIRO
Tel. : +55 21 282 13 25 Fax : +55 21 220 36 68
E-Mail : hubert@openlink.com.br

ASIA

China - SHANGHAI RADIALL Electronic Co., Ltd

No. 390 Yong He Road 200072 - SHANGHAI
Tel. : +86 21 66 52 37 88 Fax : +86 21 66 52 11 77
E-Mail : radialls@online.sh.cn

Japan - NIHON RADIALL KK

1-3-10, Higashi nihonbashi, Chuokku, TOKYO 103-0004
Tel. : +81 3 3866 2390 Fax : +81 3 3866 2391
E-Mail : emiko@radiall.co.jp

HongKong - RADIALL Electronics Ltd

Elite Industrial Centre, Room 212, 2/F
N° 883 Cheung Sha Wan Road - KOWLOON HONG KONG
Tel. : +852 29 59 38 33 Fax : +852 29 59 26 36
E-Mail : info@radiall.com.hk

India - RADIALL PROTECTRON

25 D, II Phase, Peenya Industrial Area - BANGALORE 560058
Tel. : +91 80 83 95 271 Fax : +91 80 83 97 228
E-Mail : radiall@vsnl.com

REPRESENTED IN

Argentina	Greece	New Zealand	Spain
Australia	Hungary	Norway	South Africa
Austria	Ireland	Poland	Switzerland
Belgium	Israël	Portugal	Taiwan
Ceska Rep.	Korea	Rumania	Thailand
Chile	Malaysia	Russia	Turkey
Denmark	Maroc	Singapore	
Egypt	Mexico	Slovenia	

For the above countries, please contact the local agent or RADIALL HEADQUARTERS (FRANCE)

October 2001 Edition

D6 123 CE



Registered Trade Mark